

## FD 8025 24 series

80x80x25 mm

### Features

- UL 94V-0 thermoplastic frame
- UL 94V-0 thermoplastic impeller
- Ball bearing
- Lead wires
- Polarity protection\*
- Optional functions: FG, RD, PWM
- Operating temp.: -10~+70 °C
- Storage temp.: -40~+70 °C
- 54 g



Model	Voltage VDC	Current A	Input Power (W)	Speed RPM	Airflow cfm	Static pressure (mmH2O)	Sound level dBA
FD 8025 12 B 24	12	0.11	1.32	2400	34.86	2.45	26.6
FD 8025 24 B 24	24	0.05	1.20	2400	34.86	2.45	26.6

\*: Circuit won't be burned within 5seconds when Vcc & GND are exchanged

\*\* : above specifications are subject to change without prior notice

\*\*\*: for non-standard product, contact our sale's team at [info@ventus-sa.com](mailto:info@ventus-sa.com)

### Dimensions

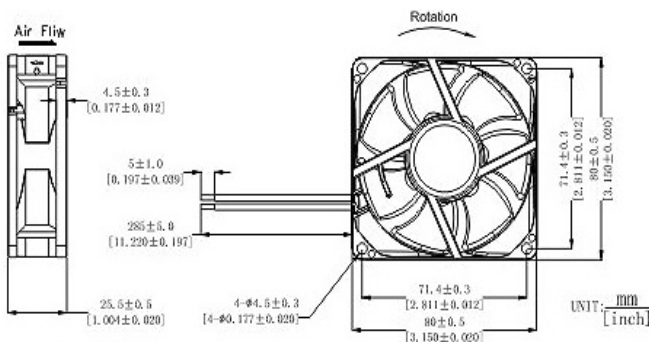

### Performance

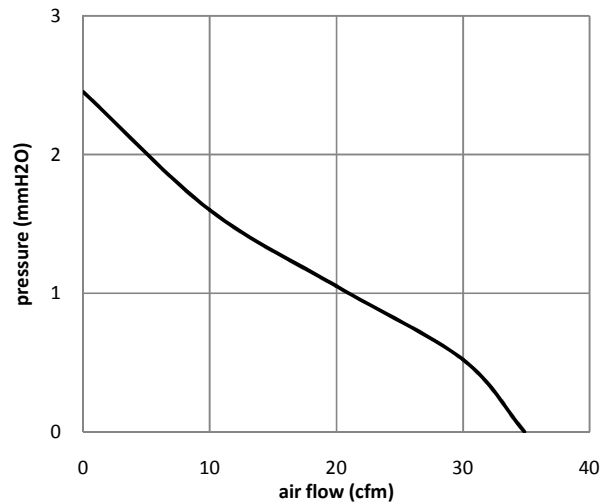

### Ordering Code:

Fan type	Dimensions	Voltage	Bearing type		Speed	optional			Electrical connections		Other specs*	
			Ball	sleeve		FG	RD	PWM	Terminals	Lead wires		
FD	8025	12/24	B	-	24	T	D	P	-	-	L	/O

\*: if the ordered item is not standard fans offered on our website, always put "/O" at the end of the ordering code and specify the project number which is unique for any non-standard products. Sales team will provide this project number together with specs sheet confirmed by both parties.

Example: FD 8025 24 B24-L