

## FA 8025 26 series (80x80x25 mm)

### Features

- Die cast Aluminum alloy frame
- UL94V-0 plastic impeller
- Ball bearing or sleeve bearing
- Electrical connections: terminals or lead wires
- Operating temp.: -30~+75 °C (ball bearing)  
-10~+70 °C (sleeve bearing)
- Life time: 50000 hrs@20 °C (ball bearing)  
30000 hrs@20 °C (sleeve bearing)
- Impedance protection
- Weight: 260 g
- Certificates: CE



Model	Voltage VAC	Frequency Hz	Current A	Input Power W	Speed RPM	Airflow CFM	Static pressure mmH <sub>2</sub> O	Sound level dBA
FA 8025 11 # 26	110/120	50/60	0.12/0.10	14/13	2550/2900	18/22	3.30/4.83	29/33
FA 8025 23 # 26	220/240	50/60	0.07/0.06	14/13	2550/2900	18/22	3.30/4.83	29/33

#: B for ball bearing and S for sleeve bearing. Refer to the ordering code below.

\*: above specifications are subject to change without prior notice

\*\* : for non-standard product, contact our sale's team at [info@ventus-sa.com](mailto:info@ventus-sa.com)

### Dimensions

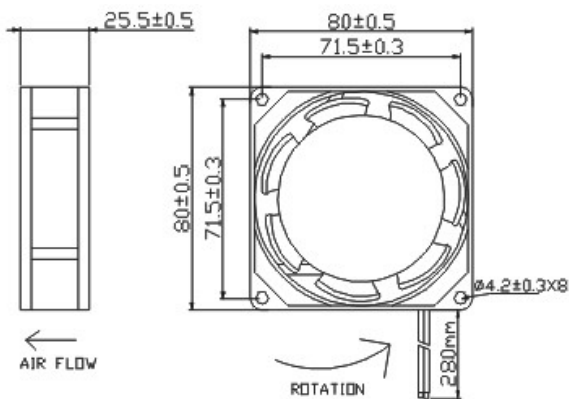

### Performance

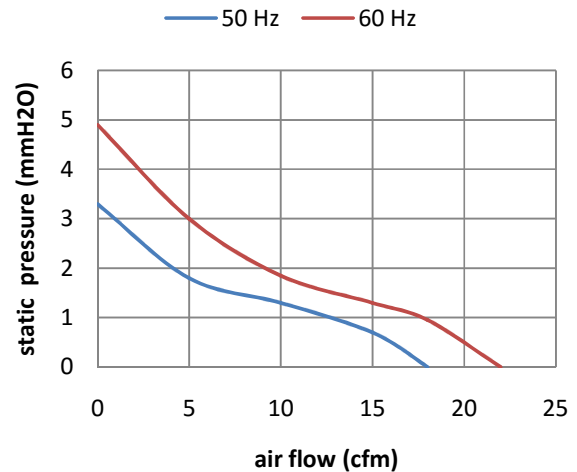

### Ordering Code:

Fan type	Dimensions	Voltage (VAC)		Bearing type		Speed	-	Electrical connections		Other specs*
		110	230	Ball	sleeve			Terminals	Lead wires	
FA	8025	11	23	B	S	26	-	C	L	/O

\*: if the ordered item is not standard fans offered on our website, always put "/O" at the end of the ordering code and specify the project number which is unique for any non-standard products. Sales team will provide this project number together with specs sheet confirmed by both parties.

Example: FA 8025 23 B 26 -C